

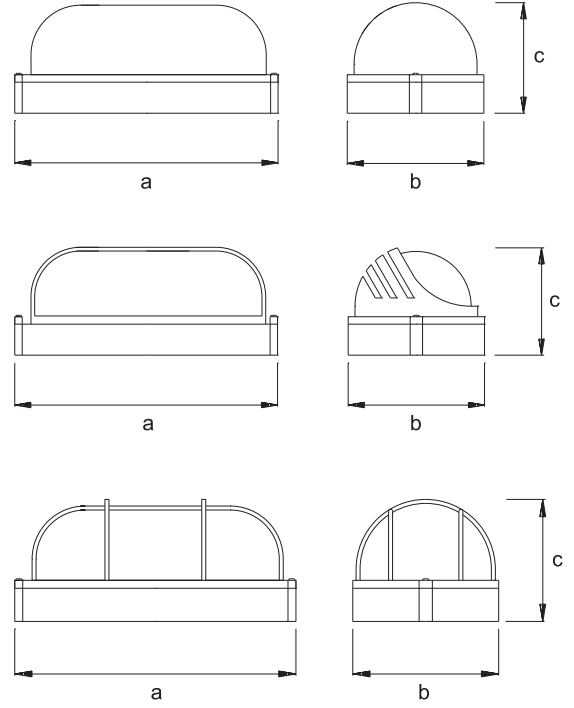

Harici Gloplar
Outdoor Globes



Oval Armatürler
Oval Luminaires



Armatür Özellikleri

Gövde : Alüminyum enjeksiyon
Duy : EN 60238
Cam : Buzlu cam
Boya : Elektrostatik toz boya

Specifications

Body : Injection aluminium
Base : EN 60238
Diffuser : Frosted glass
Coating : Electrostatic powder coating

Kod No Code No	Tip Type	Lamba Tipi Lamp Type	Güç Power (w)	Işık Akısı Luminous Flux (lm)	Akım Current (A)	Boyutlar Dimensions (mm)			Ağırlık Weight (Kg)	Hacim Volume (m ³)	Duy Base	Koli Adedi Pcs / Pack
						a	b	c				
5730-604	Oval Glas	Enkandesan	60	730	0,26	210	110	90	14,20	0,0432	E27	18
5730-606	Oval Kep	Enkandesan	60	730	0,26	210	110	92	14,20	0,0432	E27	18
5730-605	Oval Kafes 21	Enkandesan	60	730	0,26	210	110	92	14,20	0,0432	E27	18
5730-612	Oval Kafes 28	Enkandesan	100	1380	0,43	280	165	120	19,00	0,0432	E27	12

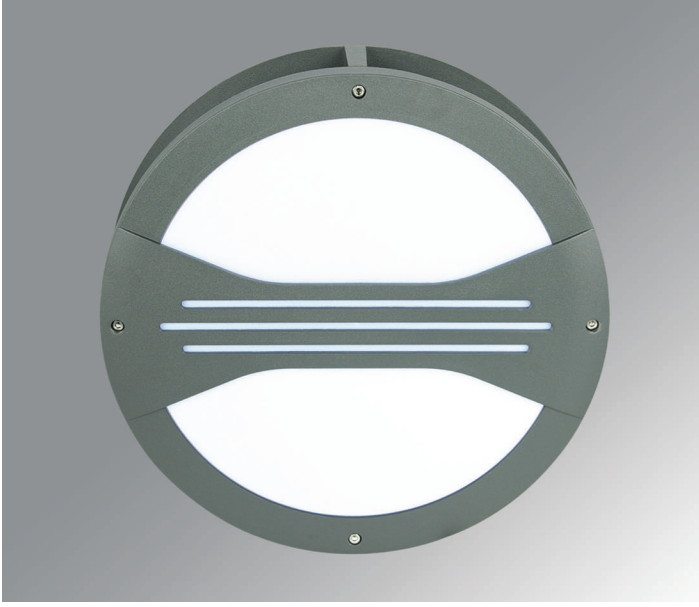

Best 35
Best 35

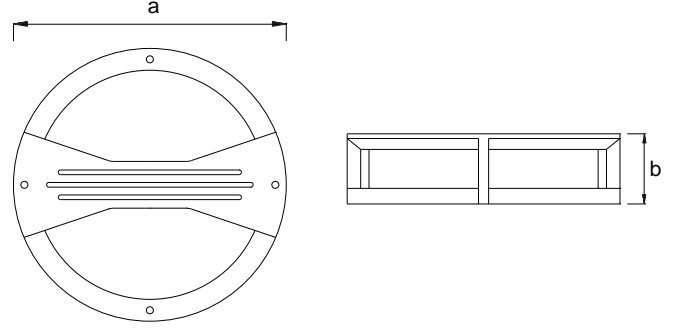

Armatür Özellikleri

Gövde : Alüminyum enjeksiyon
Duy : EN 60238
Cam : Opal PC
Boya : Elektrostatik toz boya

Specifications

Body : Injection aluminium
Base : EN 60238
Diffuser : Opal PC
Coating : Electrostatic powder coating

Kod No Code No	Tip Type	Lamba Tipi Lamp Type	Güç Power (w)	Işık Akışı Luminous Flux (lm)	Akım Current (A)	Boyutlar Dimensions (mm)		Ağırlık Weight (Kg)	Hacim Volume (m ³)	Duy Base	Koli Adedi Pcs / Pack
						a	b				
5730-570	Best 35	PL-E	2x26	2x1800	0,24	346x90		12,30	0,05976	E27	4



Kent
Kent

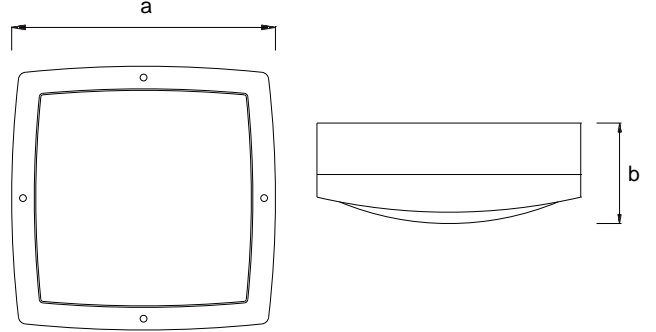

Armatür Özellikleri

Gövde : Alüminyum enjeksiyon
Duy : EN 60238
Cam : Opal PC
Boya : Elektrostatik toz boya

Specifications

Body : Injection aluminium
Base : EN 60238
Diffuser : Opal PC
Coating : Electrostatic powder coating

Kod No Code No	Tip Type	Lamba Tipi Lamp Type	Güç Power (w)	Işık Akısı Luminous Flux (lm)	Akım Current (A)	Boyutlar Dimensions (mm)		Ağırlık Weight (Kg)	Hacim Volume (m ³)	Duy Base	Koli Adedi Pcs / Pack
						a	b				
5730-560	Kent 35	PL-E	2x26	2x1800	0,24	350x130	13,50	0,0589	E27	3	

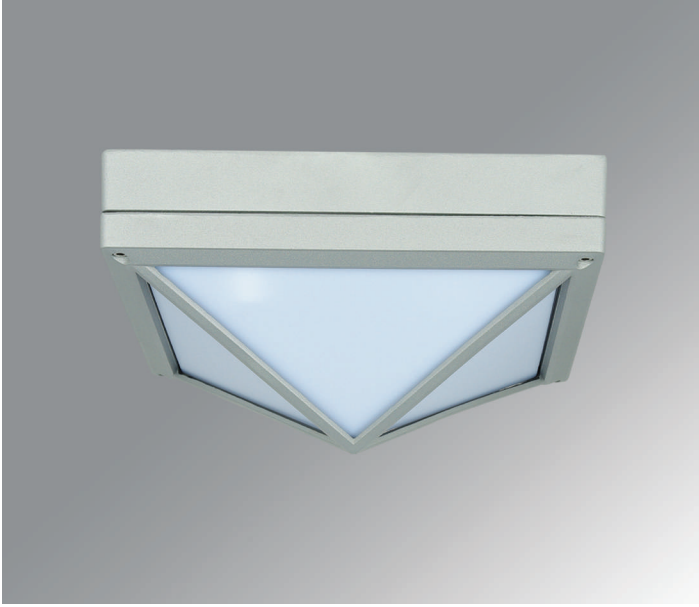

Hisar
Hisar

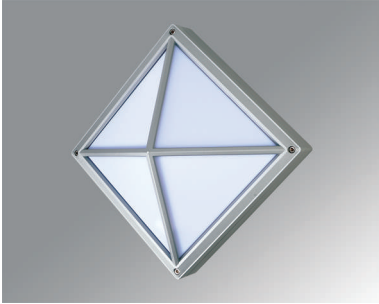
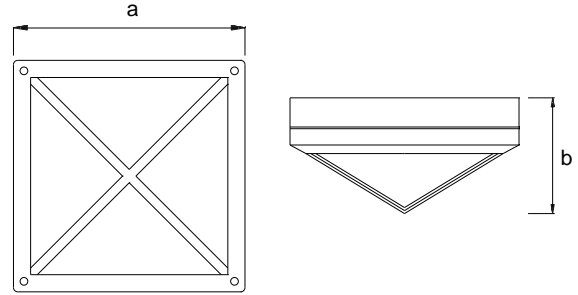

Armatür Özellikleri

Gövde : Alüminyum enjeksiyon
Duy : EN 60238
Cam : Opal PC
Boya : Elektrostatik toz boya

Specifications

Body : Injection aluminium
Base : EN 60238
Diffuser : Opal PC
Coating : Electrostatic powder coating

Kod No Code No	Tip Type	Lamba Tipi Lamp Type	Güç Power (w)	Işık Akışı Luminous Flux (lm)	Akım Current (A)	Boyutlar Dimensions (mm) a b	Ağırlık Weight (kg)	Hacim Volume (m ³)	Duy Base	Koli Adedi Pcs / Pack
5730-575	Hisar	PL-E	2x18	2x1260	0,164	270x135	14,50	0,07788	E27	6



Polo
Polo

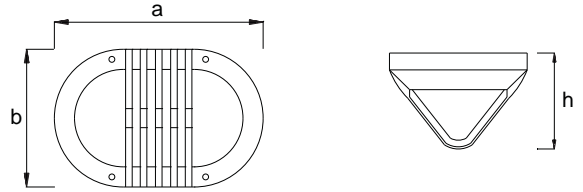
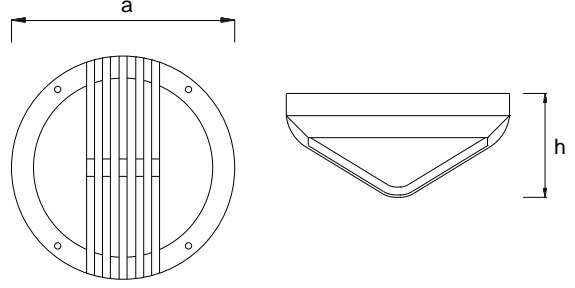

Armatür Özellikleri

- Gövde : Alüminyum enjeksiyon
Duy : EN 60238
Cam : Buzlu cam
Boya : Elektrostatik toz boya

Specifications

- Body : Injection aluminium
Base : EN 60238
Diffuser : Frosted glass
Coating : Electrostatic powder coating

Kod No Code No	Tip Type	Lamba Tipi Lamp Type	Güç Power (w)	Işık Akısı Luminous Flux (lm)	Akım Current (A)	Boyutlar Dimensions (mm)			Ağırlık Weight (Kg)	Hacim Volume (m ³)	Duy Base	Koli Adedi Pcs / Pack
						a	b	h				
5730-551	Polo 2	Enkandesan	100	1380	0,43	280	130	18,00	0,09925	E27	8	
5730-555	Polo 4	Enkandesan	100	1380	0,43	285x190x130		19,80	0,01025	E27	12	



“Club” Armatürleri
“Club” Luminaires

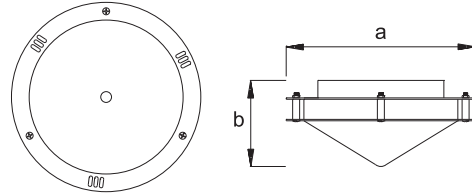
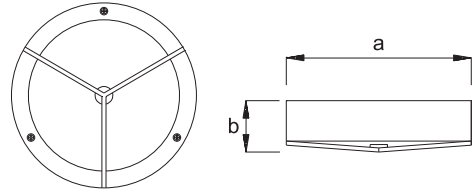
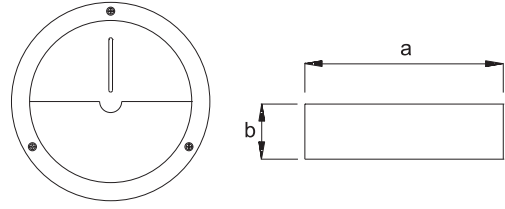

Armatür Özellikleri

Gövde : Alüminyum enjeksiyon
Duy : EN 60238
Cam : Buzlu cam
Boya : Elektrostatik toz boya

Specifications

Body : Injection aluminium
Base : EN 60238
Diffuser : Frosted glass
Coating : Electrostatic powder coating

Kod No Code No	Tip Type	Lamba Tipi Lamp Type	Güç Power (w)	Işık Akısı Luminous Flux (lm)	Akım Current (A)	Boyutlar Dimensions (mm)		Ağırlık Weight (Kg)	Hacim Volume (m³)	Duy Base	Koli Adedi Pcs / Pack
						a	b				
5730-530	Club 1	Enkandesan	60	730	0,26	270x75		14,50	0,0480	E27	8
5730-535	Club 2	Enkandesan	60	730	0,26	270x75		14,50	0,0480	E27	8
5730-540	Club 3	Enkandesan	60	730	0,26	290x120		8,50	0,0504	E27	4



“Harman” - “Yaka” - “Siperli”
“Harman” - “Yaka” - “Siperli”

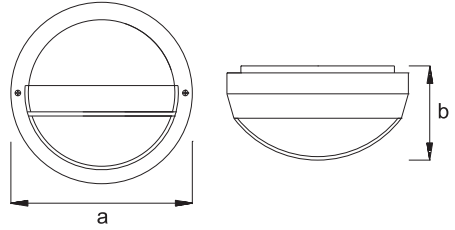
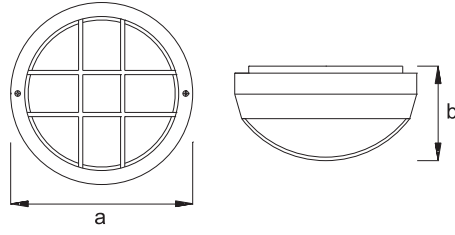
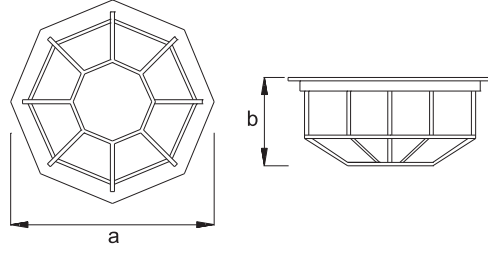

Armatür Özellikleri

Gövde : Alüminyum enjeksiyon
Duy : EN 60238
Cam : Buzlu cam
Boya : Elektrostatik toz boya

Specifications

Body : Injection aluminium
Base : EN 60238
Diffuser : Frosted glass
Coating : Electrostatic powder coating

Kod No Code No	Tip Type	Lamba Tipi Lamp Type	Güç Power (w)	Işık Akısı Luminous Flux (lm)	Akım Current (A)	Boyutlar Dimensions (mm)		Ağırlık Weight (Kg)	Hacim Volume (m³)	Duy Base	Koli Adedi Pcs / Pack
						a	b				
5730-501	Harman 21	Enkandesan	60	730	0,26	212x110		13,00	0,0600	E27	12
5730-505	Harman 27	Enkandesan	100	1380	0,43	267x130		14,50	0,0760	E27	8
5730-511	Yaka 20	Enkandesan	60	730	0,26	190x106		9,00	0,0296	E27	8
5730-516	Yaka 26	Enkandesan	100	1380	0,43	260x125		14,70	0,0368	E27	8
5730-526	Siperli	Enkandesan	100	1380	0,43	260x125		11,50	0,0276	E27	6