

01

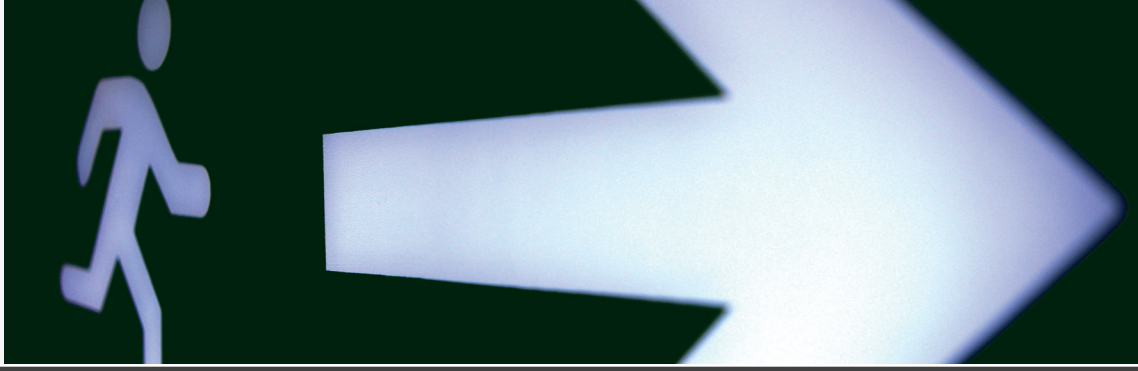

Acil Aydınlatma ve Yönlendirme Armatürleri Emergency Luminaires



Acil Aydınlatma Armatürleri Emergency Luminaires

Özellikleri

- * Enerji varken manyetik balast ile lamba yanar.
- * Enerji yokken konvertör kit ile pil üzerinden lamba yanar.
- * Pil aşırı şarj ve deşarja karşı korumalıdır.
- * NiCd pillidir.
- * Led şarj göstergelidir.
- * Çalışma süresi 1-3 saattir.
- * Elektronik balastlı uygulamalar mevcuttur.
- * İstenildiği takdirde kombo kit sistemi uygulanır.

Specifications

- * Lamp works with magnetic ballast when energy is on.
- * Lamp works with converter kit when energy is off.
- * Battery is protected against excessive charging and discharging.
- * NiCd battery is used.
- * Working time is 1-3 hours.
- * Electronic ballast application is available.
- * Kombo kit application is also available.

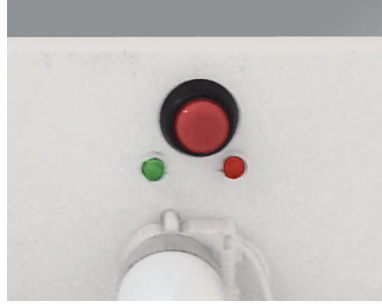
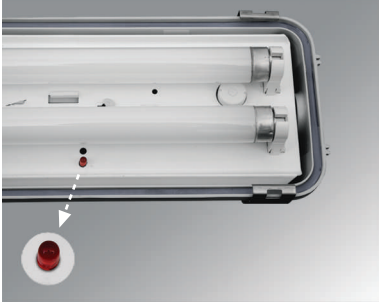
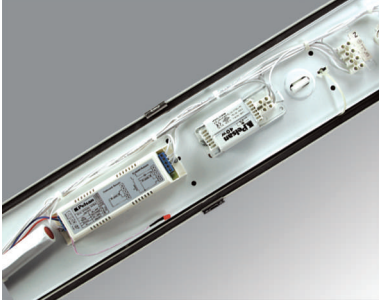

Kod No Code No	Tip Type	Lamba Tipi Lamp Type	Çalışma Süresi Working Time	Boyutlar Dimensions (mm)			Ağırlık Weight (Kg)	Hacim Volume (m³)	Koli Adedi Pcs / Pack
				a	b	c			
5017-508	2X36 TI Acil Aydınlatma Tek Lamba	L 36	1	1265	140	65	4,00	0,0163	1
5017-513	2X36 TI Acil Aydınlatma Tek Lamba	L 36	3	1265	140	65	4,20	0,0163	1
5021-304	2X36 UI Etanj Acil Aydınlatma Tek Lamba	L 36	1	1288	100	120	23,00	0,1140	6
5021-300	2X36 UI Etanj Acil Aydınlatma Tek Lamba	L 36	3	1288	100	120	24,00	0,1140	6
5011-477	4X18 S.A Parabolik Acil Aydınlatma Tek Lamba	L 18	1	595	595	80	23,00	0,1439	4
5011-478	4X18 S.A Parabolik Acil Aydınlatma Tek Lamba	L 18	3	595	595	80	23,75	0,1439	4



IP65 Etanj Emergency
IP65 Emergency

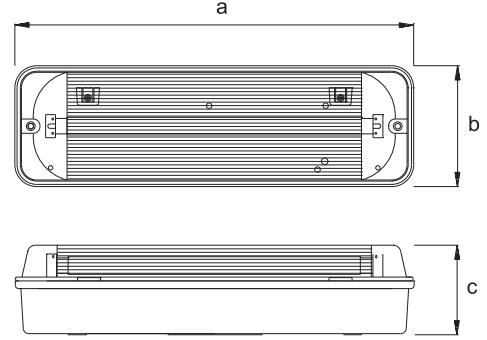

Armatür Özellikleri

- Gövde : Polimer Enjeksiyon
Duy : EN 60400
Pil : NiCd 2,4V 2,8Ah
Çalışma Pozisyonu : DC (Enerji kesildiğinde devreye girer)

Specifications

- Body : Polymer injection
Base : EN 60400
Battery : NiCd 2,4V 2,8Ah
Function mode : DC (When energy is off)

Kod No Code No	Tip Type	Lamba Tipi Lamp Type	Çalışma Süresi Working Time	Boyutlar Dimensions (mm)			Ağırlık Weight (Kg)	Hacim Volume (m ³)	Koli Adedi Pcs / Pack
				a	b	c			
5022-501	IP 65 Emergency	TLMini 8	3 saat	365	110	75	15,00	0,05265	12

EXIT ↓



05:11

ITINIZ
PULSH

ITINIZ
PULSH



“2x20” - “2x50” Spot Emergency
“2x20” - “2x50” Spot Emergency

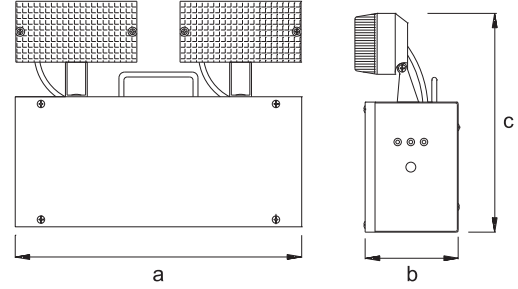

Armatür Özellikleri

- Gövde : Elektrostatik toz boyalı metal
Duy : EN 60238
Pil : NiCd 12V 12Ah
Çalışma Pozisyonu : DC (Enerji kesildiğinde devreye girer)

Specifications

- Body : Electrostatic powder coated sheet
Base : EN 60238
Battery : NiCd 12 V 12 Ah
Function mode : DC (When energy is off)

Kod No Code No	Tip Type	Lamba Tipi Lamp Type	Çalışma Süresi Working Time	Boyutlar Dimensions (mm)			Ağırlık Weight (kg)	Hacim Volume (m ³)	Koli Adedi Pcs / Pack
				a	b	c			
5514-101	2x20 spot	Halojen 20W	3	345	110	260	21,50	0,0433	3
5514-103	2x50 spot	Halojen 50W	1	345	110	260	21,50	0,0433	3



2x20 Ledli Spot Emergency
2x20 Led Spot Emergency

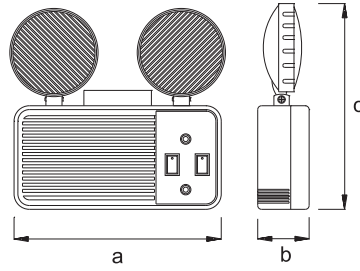

Armatür Özellikleri

- Gövde : Polimer enjeksiyon
Pil : NiCd 6V 4,5Ah
Çalışma Pozisyonu : DC (Enerji kesildiğinde devreye girer)

Specifications

- Body : Polymer injection
Battery : NiCd 6V 4,5Ah
Function mode : DC (When energy is off)

Kod No Code No	Tip Type	Lamba Tipi Lamp Type	Çalışma Süresi Working Time	Boyutlar Dimensions (mm)			Ağırlık Weight (Kg)	Hacim Volume (m ³)	Koli Adedi Pcs / Pack
				a	b	c			
5514-104	2x20 ledli	Led	5 saat	266	70	280	9,70	0,04620	6

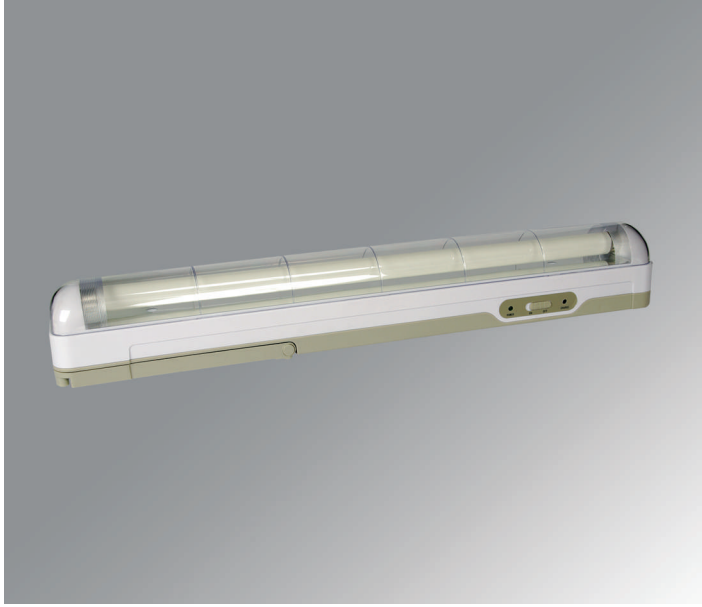

18W İbıldak
18W Emergency Lantern

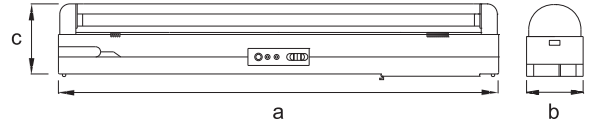

Özellikler

- * Portatif taşınabilir.
- * Duvara kolay monte edilebilir.
- * DC (Enerji kesildiğinde otomatik devreye girer)
- * Akü NiCd 6V 4,5Ah

Properties

- * Portable
- * Easy-mounting on walls.
- * DC (Automatically functions when energy is off)
- * NiCd 6V 4,5Ah battery

Kod No Code No	Tip Type	Lamba Tipi Lamp Type	Çalışma Süresi Working Time	Boyutlar Dimensions (mm)			Ağırlık Weight (Kg)	Hacim Volume (m ³)	Koli Adedi Pcs / Pack
				a	b	c			
5061-106	18 W İbıldak	TL-D 18	3 saat	660	79	95	14,40	0,05433	8



90 Ledli İpýldak 90 Led Emergency Lantern

Özellikler

- * Portatif taşınabilir.
- * Duvara kolay monte edilebilir.
- * Enerji kesildiğinde otomatik devreye girer.
- * NiCd 6V 2,3Ah pil
- * 3 konumlu anahtar (30 ledli, 60 ledli, 90ledli)
- * 2500 mcd led

Specifications

- * Portable
- * Easy-mounting on walls
- * DC automatically functions when energy is off.
- * NiCd 6V 2,3Ah battery
- * 3 mode switch (30 leds, 60 leds, 90 leds)
- * 2500 mcd led

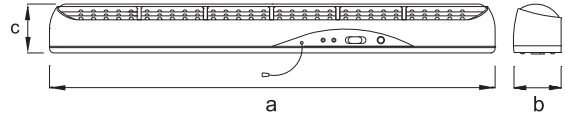

30 Ledli İpýldak 30 Led Emergency Lantern

Özellikler

- * Portatif taşınabilir.
- * Duvara kolay monte edilebilir.
- * Enerji kesildiğinde otomatik devreye girer.
- * NiCd 4V 2,0Ah pil
- * 2 konumlu anahtar (16 ledli, 30 ledli)
- * 2500 mcd led

Specifications

- * Portable
- * Easy-mounting on walls
- * DC automatically functions when energy is off.
- * NiCd 4V 2,0Ah battery
- * 2 mode switch (16 leds, 30 leds)
- * 2500 mcd led

Kod No Code No	Tip Type	Lamba Tipi Lamp Type	Çalışma Süresi Working Time	Boyutlar Dimensions (mm)			Ağırlık Weight (Kg)	Hacim Volume (m ³)	Koli Adedi Pcs / Pack
				a	b	c			
5061-114	90 ledli İpýldak	Led	10/9/5,5	660	70	70	10,70	0,04093	8
5061-115	30 ledli İpýldak	Led	10/5	355	50	60	12,00	0,04742	20



“Profil” Acil Yönlendirme Armatürü
“Profile” Emergency Exit Luminaires

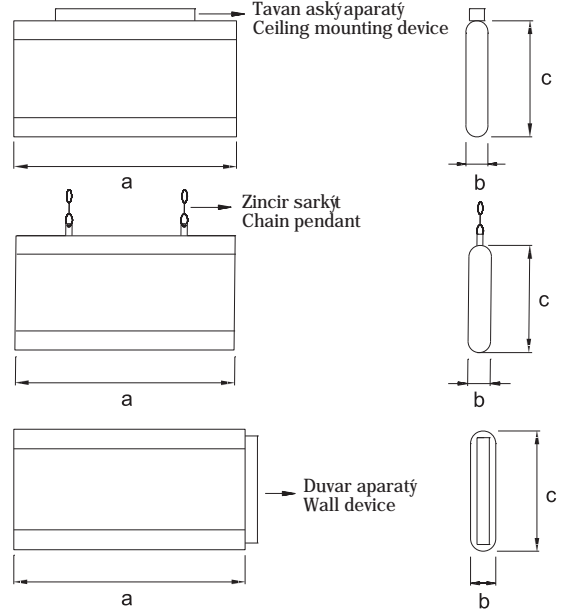

Armatür Özellikleri

Gövde : Alüminyum profil
Cam : Beyaz PMMA
Duy : EN 60400
Ballast : EN 60921 EN 61347-2-8
Starter : EN 60155
Pil : NiCd
Boya : Elektrostatik toz boya

* AC seçeneđi uygulanmaktadır.
* Çalışma süresi 1 saat uygulanmaktadır.

Specifications

Body : Aluminium profile
Diffuser : White PMMA
Base : EN 60400
Ballast : EN 60921 EN 61347-2-8
Starter : EN 60155
Battery : NiCd
Coating : Electrostatic powder coating

* AC option can be applied.
* Working time is 1 hour.



Kod No Code No	Model	Tip Type	Lamba Tipi Lamp Type	Çalışma Süresi Working Time	Boyutlar Dimensions (mm)			Ağırlık Weight (Kg)	Hacim Volume (m ³)	Koli Adedi Pcs / Pack
					a	b	c			
5513-225	Duvar	Tek yüz acilde DC	TLMini 8	3	335	50	200	2,80	0,0034	1
5513-227	Duvar	Çift yüz acilde DC	TLMini 8	3	335	50	200	2,80	0,0034	1
5513-226	Duvar	Tek yüz acilde ve enerjide AC/DC	TLMini 8	3	335	50	200	2,80	0,0034	1
5513-228	Duvar	Çift yüz acilde ve enerjide AC/DC	TLMini 8	3	335	50	200	2,80	0,0034	1
5513-248	Zincir	Tek yüz acilde DC	TLMini 8	3	335	50	200	2,80	0,0034	1
5513-249	Zincir	Çift yüz acilde DC	TLMini 8	3	335	50	200	2,80	0,0034	1
5513-247	Zincir	Tek yüz acilde ve enerjide AC/DC	TLMini 8	3	335	50	200	2,80	0,0034	1
5513-244	Zincir	Çift yüz acilde ve enerjide AC/DC	TLMini 8	3	335	50	200	2,80	0,0034	1
5513-233	Tavan	Tek yüz acilde DC	TLMini 8	3	335	50	200	2,80	0,0034	1
5513-237	Tavan	Çift yüz acilde DC	TLMini 8	3	335	50	200	2,80	0,0034	1
5513-234	Tavan	Tek yüz acilde ve enerjide AC/DC	TLMini 8	3	335	50	200	2,80	0,0034	1
5513-238	Tavan	Çift yüz acilde ve enerjide AC/DC	TLMini 8	3	335	50	200	2,80	0,0034	1



“Sıva Altı Duvar” Acil Yönlendirme Armatürü
“Wall Type” Emergency Exit Luminaires

Armatür Özellikleri

Gövde : Elektrostatik toz boyalı metal
Cam : Beyaz PMMA
Duy : EN 60400
Ballast : EN 60921 EN 61347-2-8
Starter : EN 60155
Pil : NiCd

Specifications

Body : Electrostatic powder coated sheet
Diffuser : White PMMA
Base : EN 60400
Ballast : EN 60921 EN 61347-2-8
Starter : EN 60155
Battery : NiCd

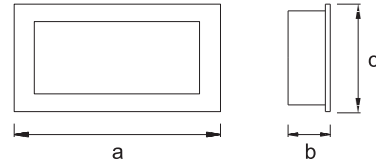

“Sıva Altı Tavan” Acil Yönlendirme Armatürü
“Ceiling Type” Emergency Exit Luminaires

Armatür Özellikleri

Gövde : Elektrostatik toz boyalı metal
Duy : EN 60400
Ballast : EN 60921 EN 61347-2-8
Starter : EN 60155
Pil : NiCd

Specifications

Body : Electrostatic powder coating sheet
Base : EN 60400
Ballast : EN 60921 EN 61347-2-8
Starter : EN 60155
Battery : NiCd

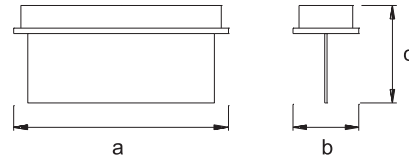

Kod No Code No	Model	Tip Type	Lamba Tipi Lamp Type	Çalışma Süresi Working Time	Boyutlar Dimensions (mm)			Ağırlık Weight (Kg)	Hacim Volume (m ³)	Koli Adedi Pcs / Pack
					a	b	c			
5513-201	Duvar	Acilde DC	TLMini 8	1	370	50	152	2,10	0,0034	1
5513-203	Duvar	Acilde DC	TLMini 8	3	370	50	152	2,20	0,0034	1
5513-202	Duvar	Acilde ve enerjide AC/DC	TLMini 8	1	370	50	152	2,20	0,0034	1
5513-204	Duvar	Acilde ve enerjide AC/DC	TLMini 8	3	370	50	152	2,50	0,0034	1
5513-211	Tavan	Acilde DC	TLMini 8	1	362	125	190	2,00	0,0034	1
5513-213	Tavan	Acilde DC	TLMini 8	3	362	125	190	2,10	0,0034	1
5513-212	Tavan	Acilde ve enerjide AC/DC	TLMini 8	1	362	125	190	2,30	0,0034	1
5513-214	Tavan	Acilde ve enerjide AC/DC	TLMini 8	3	362	125	190	2,50	0,0034	1



“Exiled” Acil Yönlendirme Armatürü
“Exiled” Emergency Exit Luminaires

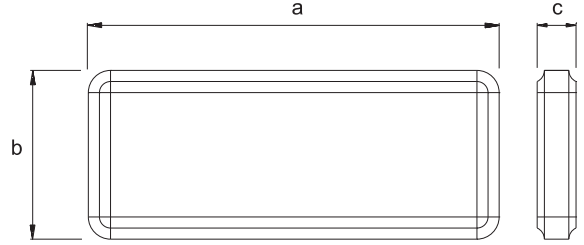

Armatür Özellikleri

Gövde : Alüminyum profil
Pil : NiCd
Çalışma pozisyonu : AC/DC Enerjide ve enerji yokken çalışır

Specifications

Body : Aluminium profile
Battery : NiCd
Function mode : AC/DC (Both when energy is on and off)

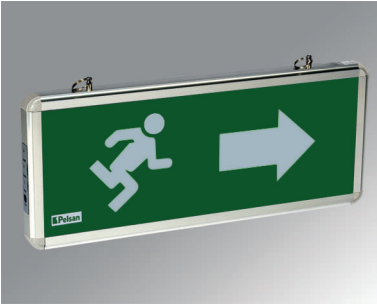

Kod No Code No	Model	Tip Type	Lamba Tipi Lamp Type	Çalışma Süresi Working Time	Boyutlar Dimensions (mm)			Ağırlık Weight (Kg)	Hacim Volume (m ³)	Koli Adedi Pcs / Pack
					a	b	c			
5513-151	Exiled	AC/DC Çift yüz exit çıkış yazılı	Led	3	360	24	150	7,50	0,0239	10
5513-152	Exiled	AC/DC Tek yüz exit çıkış yazılı	Led	3	360	24	150	6,50	0,0239	10
5513-153	Exiled	AC/DC Çift yüz exit koşan adam ok	Led	3	360	24	150	7,50	0,0239	10
5513-154	Exiled	AC/DC Tek yüz exit koşan adam sağ ok	Led	3	360	24	150	6,50	0,0239	10
5513-155	Exiled	AC/DC Tek yüz exit koşan adam sol ok	Led	3	360	24	150	6,50	0,0239	10



“Plexiled” Acil Yönlendirme Armatürü
“Plexiled” Emergency Exit Luminaires

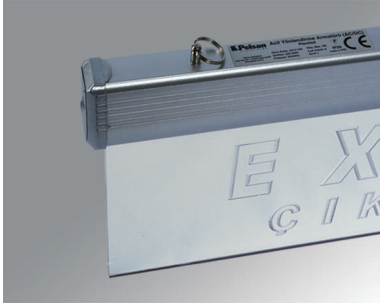
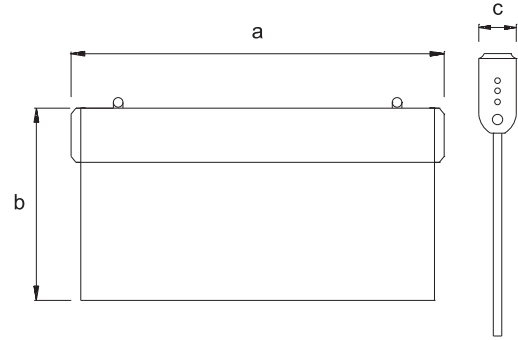

Armatür Özellikleri





















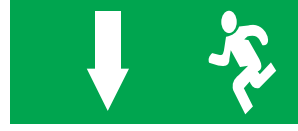
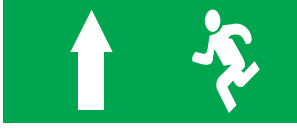









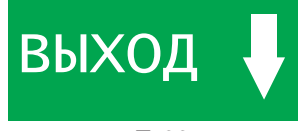







- Gövde : Alüminyum profil
Cam : Exit çıkış yazılı PMMA
Pil : NiCd
Çalışma pozisyonu : AC/DC Enerjide ve enerji yokken çalışır

Specifications

- Body : Aluminium profile
Diffuser : Exit sign PMMA
Battery : NiCd
Function mode : AC/DC (Both when energy is on and off)

Kod No Code No	Model	Tip Type	Lamba Tipi Lamp Type	Çalışma Süresi Working Time	Boyutlar	Brüt Ağırlık Gross Weight (Kg)	Hacim Volume (m ³)	Koli Adedi Pcs / Pack	
					Dimensions (mm)				
					a	b	c		
5513-150	Plexiled	AC/DC Acilde ve enerjide	Led	3 saat	400x26x200	10,00	0,03427	10	

Yönlendirme Levhaları
Direction Legends

			
E-1	E-2	E-3	E-4
			
E-5	E-6	E-7	E-8
			
E-9	E-10	E-11	E-12
			
E-13	E-14	E-15	E-16
			
E-17	E-18	E-19	E-20
			
E-21	E-22	E-23	E-24
			
E-25	E-26	E-27	E-28
			
E-29	E-30	E-31	E-32
			
E-33	E-34	E-35	E-36
			
E-37	E-38	E-39	E-40

EXIT ↓

EXIT →

